

True-L Grecian Left Order Form

Date: _____ Due: _____

DEALER

Company: _____
Address: _____
CITY STATE ZIP _____
Contact: _____ Phone: _____
E-Mail: _____

DISTRIBUTOR

Company: _____
Address: _____
CITY STATE ZIP _____
Contact: _____ Phone: _____
E-Mail: _____

SHIPPING INSTRUCTIONS

Branch: Dealer: Pick Up:

Ship Via: _____
Other: _____

ORDER INFORMATION

PO #: _____
Job Name: _____
Price: _____
Barcode: _____

Wall Pattern: _____
Floor Pattern: _____

MOUNTING

Beaded: Overlap: Overlap Size: _____ INCHES

COMMENTS

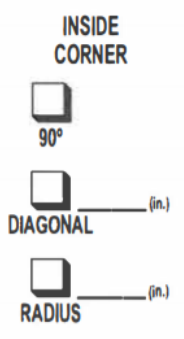
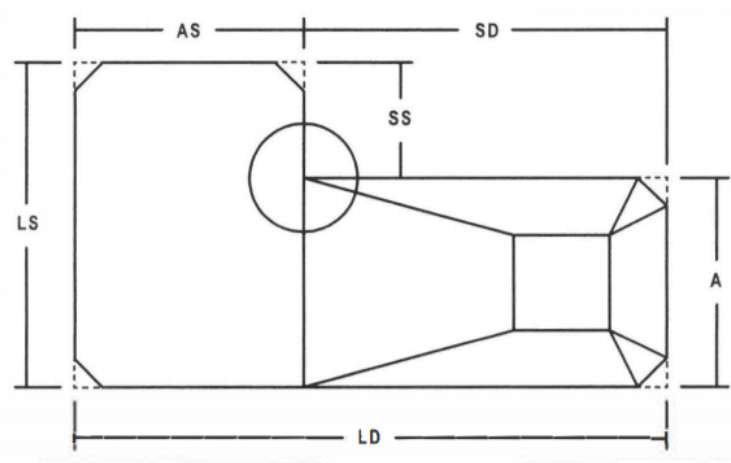

GRECIAN CORNERS

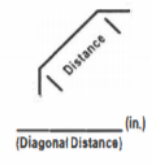

"NOTE"
MEASURE TO SQUARED CORNERS

HOPPER

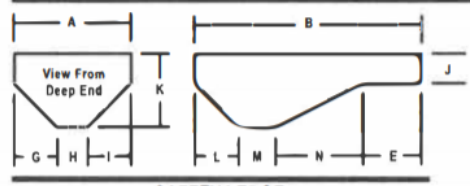
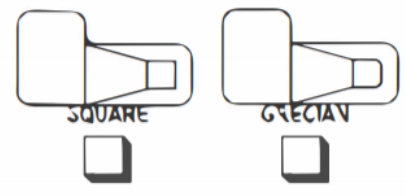

SAFETY LEDGE



COVE

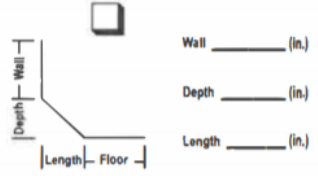

MEASUREMENTS

- (A): _____ (ft.) _____ (in.) (L): _____ (ft.) _____ (in.)
 (B): _____ (ft.) _____ (in.) (M): _____ (ft.) _____ (in.)
 (E): _____ (ft.) _____ (in.) (N): _____ (ft.) _____ (in.)
 (G): _____ (ft.) _____ (in.) (AS): _____ (ft.) _____ (in.)
 (H): _____ (ft.) _____ (in.) (LD): _____ (ft.) _____ (in.)
 (I): _____ (ft.) _____ (in.) (LS): _____ (ft.) _____ (in.)
 (J): _____ (ft.) _____ (in.) (SD): _____ (ft.) _____ (in.)
 (K): _____ (ft.) _____ (in.) (SS): _____ (ft.) _____ (in.)

POOL MANUFACTURER, IF KNOWN:

DO NOT INCLUDE STEPS ACROSS THE WIDTH OF THE POOL IN THE OVERALL LENGTH 'B' MEASUREMENT

STEP DETAILS

INDICATE POSITION OF VINYL STEP IF APPLICABLE

1 2 3

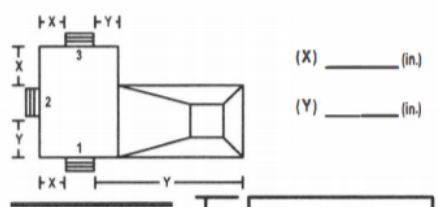

IS STEP INSIDE POOL PERIMETER?

YES NO

VINYL STEP

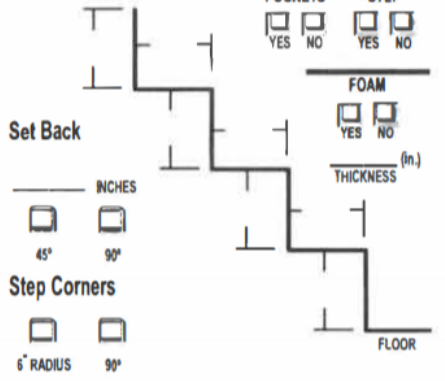

Self Check
G+H+A=?
E+L+M+N=B?
STEP RISERS=J?